

## 6 DISC IN-DASH CD CHANGER

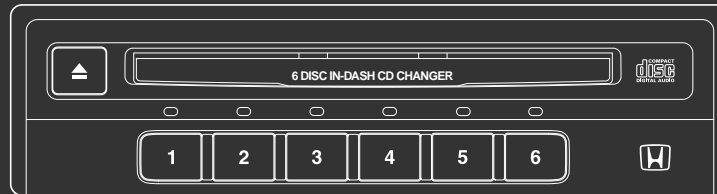

**P/N: 08A06-MCA-B00**

# Contents

Precautions .....	3
Proper Care of Your CDs .....	5
CD Changer Operation .....	7
Installation .....	13
In Case of Difficulty .....	14
Switching the address setting .....	17

Please write the serial number (on the bottom of the unit) in the space below.  
Keep this booklet as a record of your purchase to help identify the unit if it's stolen.

**Serial No.:** \_\_\_\_\_

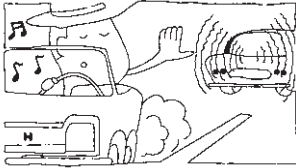

## VOLUME

For your driving safety, keep the volume low enough to be aware of road and traffic conditions.



## LIQUIDS

Do not place drinks or water on or near the unit, cassettes or CDs. If liquids drop on the unit cassettes or CDs, it can cause damage.

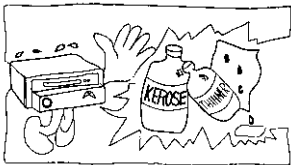

## OUTSIDE CLEANING

Use a soft cloth to clean the radio. Do not use kerosene, thinner or any other type of solvent.

## FOR DRIVING SAFETY

Do not insert or eject a CD while driving as it is dangerous and may result in an accident.

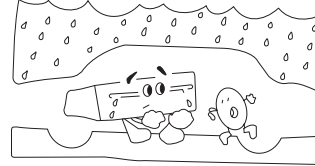

## MOISTURE CONDENSATION

You may notice the playback sound wavering. When this happens, remove the CD from the player and wait about an hour or until the moisture evaporates.

# Precautions

## CAUTIONS DURING PLAYBACK

Playing a CD while driving on a very bumpy road may result in skips. This will not scratch the CD or damage the player. The noise level on CDs is much lower than on analog-type records or tapes. Therefore, before playing a CD, turn the volume down all the way then adjust the level by gradually turning the volume up once playback begins. Do not turn the volume up too abruptly as this could damage the speakers.

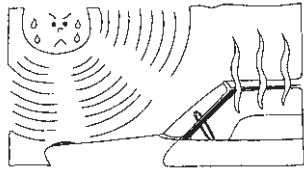

## TEMPERATURE IN THE VEHICLE

In order to ensure proper performance, be sure the temperature in your vehicle is between  $-10^{\circ}\text{C}$  and  $60^{\circ}\text{C}$  before turning your player on. Good air circulation is essential to prevent heat build-up in the unit (especially in hot weather).



## COMPACT DISC TYPE

Only compact discs containing the mark shown can be used.

## PRECAUTIONS WHEN OPERATING THIS PRODUCT

- Do not press on the CD loading slot door when it opens or closes.
- The CD loading slot door opens and closes automatically. Do not force it open or closed manually.
- When loading multiple CDs in this product, insert a single CD each time the CD loading slot door opens. Do not insert more than one CD at a time.
- Do not press on a CD when you have ejected it.
- Do not insert anything other than a CD in the CD loading slot.

# Proper Care of Your CDs

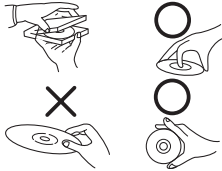

## ● PROPER HANDLING

Handle CDs as shown. Do not drop CDs. Hold CDs so you will not leave fingerprints on the surface. If the surface is scratched, it may cause the pickup to skip signal tracks. Do not put tape, paper, or gummed labels on the CD. Do not write on the CD.



## ● KEEP YOUR CDS CLEAN

Fingerprints, dust or soil on the surface could cause the pickup to skip signal tracks. For routine cleaning, wipe the playing surface with a clean, soft, dry cloth from the center of the CD to the outer edge. If the surface is heavily soiled, dampen a clean soft cloth in a solution of mild neutral detergent before cleaning the CD.



## ● DAMAGED CDS

Do not attempt to play cracked, warped, or otherwise damaged CDs. Playing a bad CD could severely damage the playback mechanism.



## ● STORAGE

When not in use, place your CDs in their individual cases and store them in a cool place away from the sun, heat, and dust.

# Proper Care of Your CDs

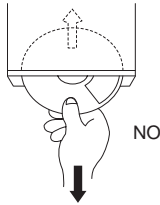

## ● NEVER ATTEMPT THE FOLLOWING

Do not grip or pull out the CD while it is being pulled back into the player by the automatic reloading mechanism.

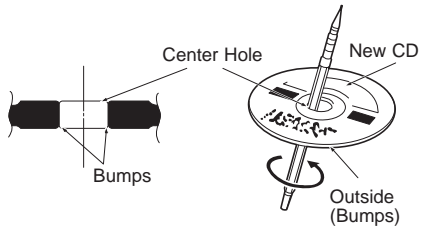

## ● CAUTION FOR NEW CDS

When a new CD is inserted into the player, the CD may fail to play after initial loading. This is caused by small bumps around the center hole and outside of CD that prevent proper loading. To remove the bumps, rub the inside edge of the hole and outside edge of the CD with a ball-point pen or other such instrument, then insert the CD again.

### NOTE:

The mechanism automatically prevents a CD with this problem from playing as a protective measure. This is not an indication of faulty operation.



## ● IRREGULAR SHAPED CDS

Be sure to use round shape CD's only.  
Special shape CD's may cause damage to the mechanism.

# CD Changer Operation

## EXPLANATION OF THE HAND MARKS



Press momentarily.



Press and hold for at least 3 seconds.

## LOADING THE CD (1 of 2)

The CD Changer operates with the same controls used for the audio system. For operation, refer to the audio system section of the Owner's Manual for your radio.

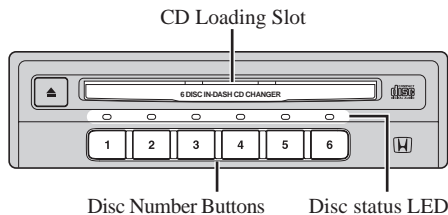

**1**

Flashes green

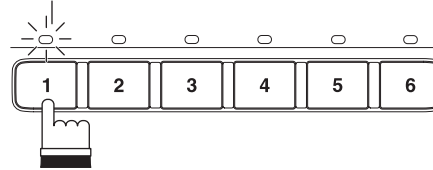

Press one of the buttons (1–6) to select the desired disc number for the CD you want to load.

- LED flashes green.

Flashes green and orange

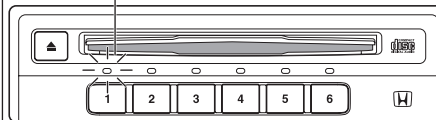

After a few seconds the CD loading slot door opens, and the LED flashes green and orange. (Green → Orange → Green → Orange)

- If you do not load a CD within about 15 seconds, the door will close. Pressing the same disc number button again or pressing the eject button will cause the door to close.

# CD Changer Operation

## LOADING THE CD (con't)

You can load a CD under a selected disc number. The system will automatically playback when the CD is loaded.

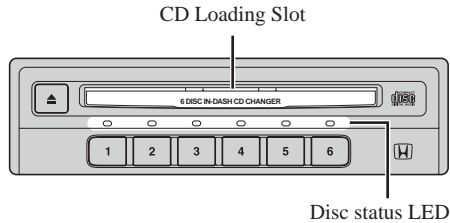

**2**

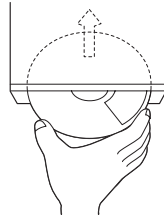

Insert the CD with the label side up.

- When loading is complete, LED will stop flashing and remain lit.

Note: This unit is not designed to handle 8 cm CD's.

Do not attempt to load it alone or with adapter. It may cause the unit to malfunction.

- Notes:
- Repeat steps **1** and **2** to load CDs in other disc numbers.
  - The unit may go into CD eject mode when it detects improper CD loading. Wait 2 seconds before inserting the CD for loading.



## SELECTING A CD

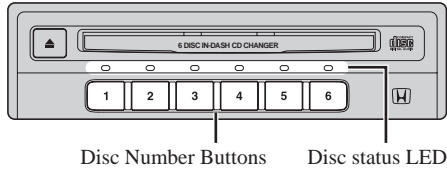

**1**

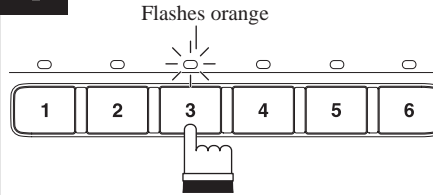

Press one of the buttons (1–6) to select a desired CD for play.

- Green LED indicates CDs are stored and orange LED indicates currently selected CD.
- While CDs are being changed, the LED flashes orange until CD changing has been completed, then it lights orange.
- You can also select a desired CD by using preset buttons or upward button on the radio.

# CD Changer Operation

## EJECTING THE CD (1 of 2)

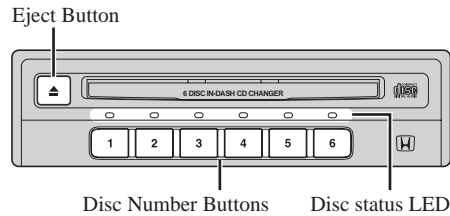

**1**

Lights green  
↓  
Flashes orange  
↓  
Lights orange

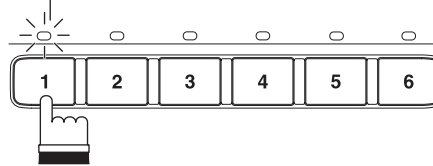

Press one of the buttons (1–6) to select the disc number for the CD you want to eject.

**2**

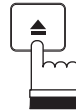

Then press eject button to eject the CD.

- The LED flashes green and the CD is ejected.

## EJECTING THE CD (con't)

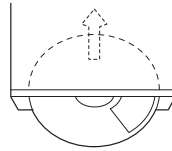
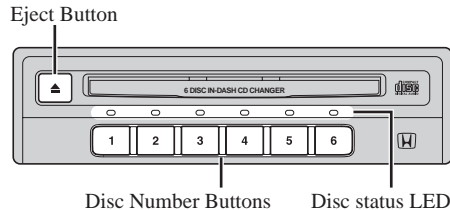

**Note:** If you do not remove the ejected CD from the CD loading slot within about 15 seconds, it is automatically reloaded. If you press the eject button, or press the ejected CD's disc number button (the Disc status LED that's flashing green), the CD is immediately reloaded.

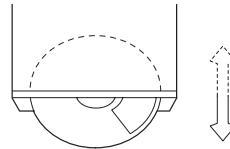

**Note:** If you leave the ejected CD in the CD loading slot, and press the disc number button for a CD that's loaded (the Disc status LED is lit green), the ejected CD is reloaded and the CD loaded in the disc number you selected is ejected instead. This function is convenient when the ejected CD is different from the one you want to eject.

- Notes:**
- Pull the CD out. The LED flashes green and orange, and this product switches to the CD loading standby mode.
  - You can eject CDs even if the ignition is switched OFF. In this case, you cannot perform step 1 to select a CD. When you press the eject button, the currently selected CD is ejected.  
Also, when you pull a CD out, the door immediately closes. (This unit does not switch to the CD loading standby mode.)

# CD Changer Operation

## ILLUMINATION

This product is equipped with two illumination colors, white and orange. You can select the desired illumination color.

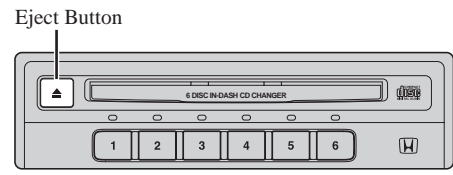

**1**

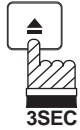

The illumination color changes each time you press and hold the eject button for 3 seconds or longer.

## SHIPPING BRACKET

A bracket have been attached to the top of the Changer for protection during shipment.

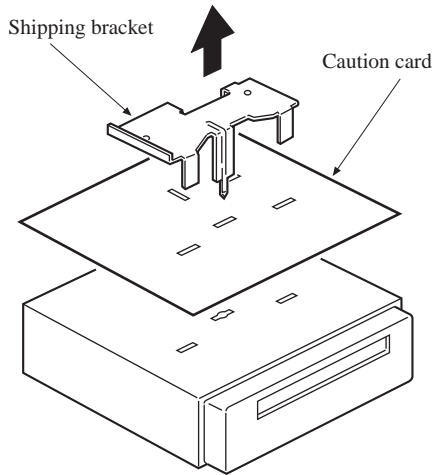

A bracket is attached to this unit to protect it from shocks during shipment. Be sure to remove this bracket before installing this unit in your car (before connecting). Be careful not to injure yourself on the edges or other parts of the bracket when removing it. Also, do not reinsert the shipping bracket once you have operated this unit as this will result in damage.

# In Case of Difficulty

If you encounter a problem, please review the items in the guide. This guide will help you isolate the problem if the unit is

at fault. Otherwise, make sure the rest of your system is properly connected or consult your authorized HONDA dealer.

## INITIAL POWER UP

SYMPTOM	CAUSE	SOLUTION
No Function	Car's ignition is off.	Turn the ignition on. This unit will not operate with ignition off.
	Power off.	Turn on the control unit.
	Improper connection of bus.	Reconnect the bus cable.
Functions OK but no sound.	Volume level too low.	Turn the volume control clockwise to increase volume.
Inoperative (no output)	Temperature inside vehicle is over 60°C.	Wait until temperature inside the vehicle is lower than 60°C.
	Moisture condensation.	Wait until moisture condensation evaporates.
Sound skips from vibration.	Improper installation.	Check installation and tighten any bracket screws that are loose.
	Dirty CD.	Clean CD. See "Proper Care of Your CDs".
	Scratched CD.	Change CD.
Disc Stuck.	Disc change mechanism malfunction.	Press the eject button. If the CD cannot eject, consult your HONDA dealer.
No play.	The CD mode is not activated.	Press the CD mode button on the radio unit.
	The CD is loaded upside down.	Eject the CD and reload it with the label side up.

## ERROR MODE

INDICATION	CAUSE	SOLUTION
E - 0 1	CD Changer malfunction.	Press the eject button, press one of the disc number buttons (1–6), switch the control unit source OFF once, or switch to another source other than CD and then switch back to CD. If performing any of these operations does not cancel the E-01 indication, consult your HONDA dealer.
- - - H	High temperature.	Will disappear when the temperature returns to operation range.
E - E E	Miss connection or disconnection of CD Changer.	Check connection between CD Changer and control unit. See your HONDA dealer.
- - -	No CD in the CD Changer.	Insert the CD.

# In Case of Difficulty

## SYMPTOMS

- Skips.
- Stuck on one track.
- CD ejects during play.

## CAUSE

Scratches. ①  
Fingerprint marks or dust. (Unclean surface.) ②

## SOLUTION

- Handle CD by edge only.
- Keep CD clean by using a cleaning kit specifically designed for CDs.
- Load CD straight and level, not at an angle, to prevent further scratching.

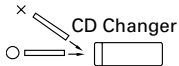

## SYMPTOMS

- CD loads, then ejects after a few seconds.

## CAUSE

CD not being centered on clamping mechanism. ④

## SOLUTION

- CD center hole defective, preventing table of contents (TOC) to be read, triggering the eject mechanism. Defective CD should not be in CD Changer.

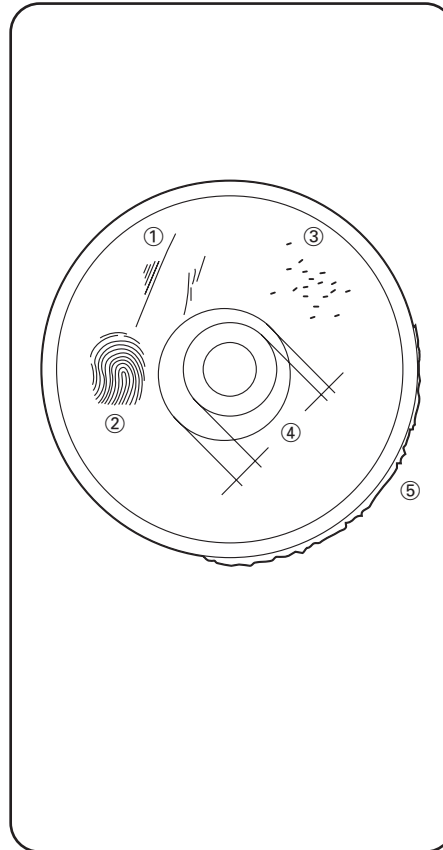

## SYMPTOMS

- Skips.
- Stuck on one track.
- CD ejects during play.

## CAUSE

Pin holes in CD caused during stamping process-reflective material missing. ③

## SOLUTION

- Check for pin holes by holding CD up to a light source and observing it as illustrated.
- Defective CD should not be used in CD Changer.

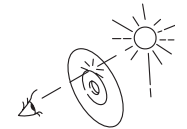

## SYMPTOMS

- CD loads, then ejects after a few seconds.

## CAUSE

Rough edge. ⑤

## SOLUTION

- Rough edges may touch mechanism parts and can be corrected by lightly sanding CD edges.



# Switching the address setting

To enable identification of CD Changers when two or more are connected, assign each one with a different address setting.

address setting.

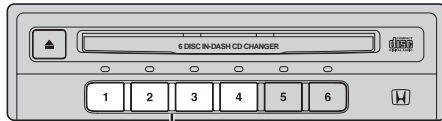

Disc Number Buttons

**1**

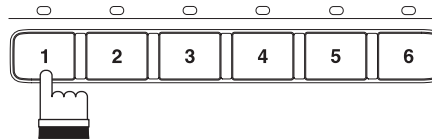

To switch the address setting, turn the ignition switch from OFF to ACC while pressing one of the buttons (1–4).

Notes: • When two or more CD Changers are connected, correct operation is not possible if the same address setting is used for more than one unit. Be sure to set addresses correctly as indicated above.





## SPECIFICATIONS

### General

Power source ..... 13.2 V DC (10.8 – 15.2 V allowable)  
Grounding system ..... Negative type  
Standby current ..... 2 mA or less  
Rated current consumption ..... 600 mA max.  
Maximum current consumption ..... 1.5 A max.  
Dimensions (chassis size) ..... 180 (W) × 50 (H) × 165 (D) mm  
Weight ..... 1.6 kg

### CD player

System ..... Compact disc audio system  
Usable discs ..... Compact disc  
Signal format ..... Sampling frequency: 44.1 kHz  
Number of quantization bits: 16;linear  
Frequency characteristics ..... 5 – 20,000 Hz  
Signal-to-noise ratio ..... 93 dB (1kHz) (IHF-A network)  
Dynamic range ..... 92 dB (1kHz)  
Number of channels ..... 2 (stereo)

